

Ersatzteilblatt

für Lokomotive BR 151

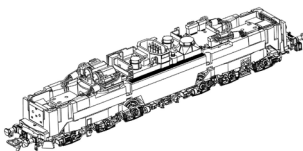

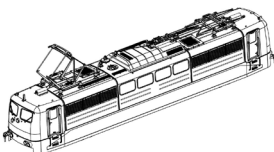

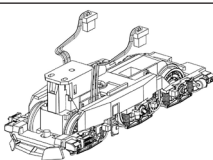
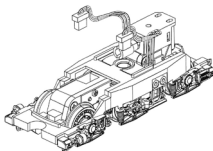
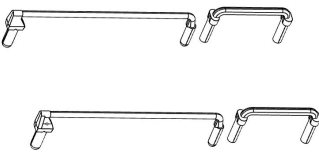
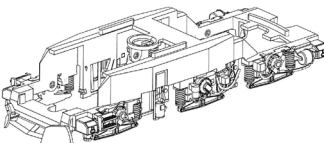
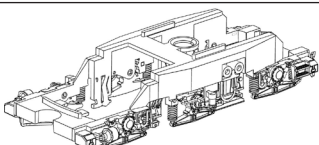

für Lokomotive BR 151 (ESU Art.-Nr. 31035, 31036, 31037, 31038)

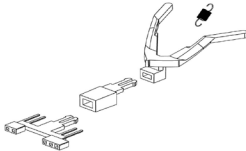
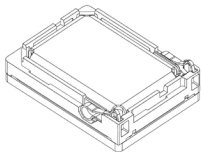
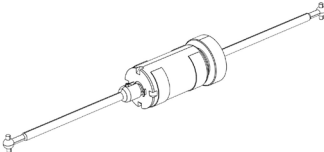
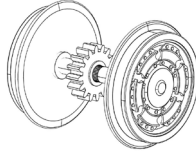
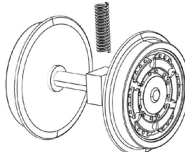
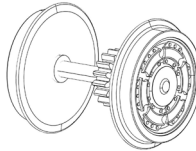
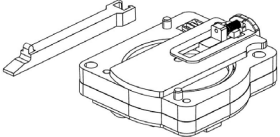
Artikel-Nr. Ersatzteile 151 070 DB (31035)	Artikel-Nr. Ersatzteile 151 088 DB (31036)	Artikel-Nr. Ersatzteile 151 087 DB (31037)	Artikel-Nr. Ersatzteile 162004 Hectorrail (31038)	
35035.SP.01	35036.SP.01	35037.SP.01	35038.SP.01	
Chassis komplett mit PCBA und Motor, ohne Lautsprecher, Decoder				
35035.SP.02	35036.SP.02	35037.SP.02	35038.SP.02	
Gehäuse komplett				
35035.SP.03	35036.SP.03	35035.SP.03	35035.SP.03	
Drehgestell 1 komplett mit Steckern				
35035.SP.04	35036.SP.04	35035.SP.04	35035.SP.04	
Drehgestell 2 komplett mit Steckern				
35035.SP.05	35035.SP.05	35035.SP.05	35035.SP.05	
Griffstangen Führerstand lang und kurz				
35035.SP.06	35036.SP.06	35035.SP.06	35035.SP.06	
Set Drehgestellblenden DG1				
35035.SP.07	35036.SP.07	35035.SP.07	35035.SP.07	
Set Drehgestellblenden DG2				

für Lokomotive BR 151 (ESU Art.-Nr. 31035, 31036, 31037, 31038)

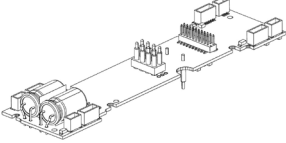
Artikel-Nr. Ersatzteile 151 070 DB (31035)	Artikel-Nr. Ersatzteile 151 088 DB (31036)	Artikel-Nr. Ersatzteile 151 087 DB (31037)	Artikel-Nr. Ersatzteile 162004 Hectorrail (31038)	
35035.SP.08	35036.SP.08	35035.SP.08	35035.SP.08	
Set Kupplungsdeichsel, Feder, Kupplungsnormschacht, Schacht für Bremsschläuche				
00623-27267	00623-27267	00623-27267	00623-27267	
Lautsprecher				
35035.SP.11	35035.SP.11	35035.SP.11	35035.SP.11	
Motor mit Kardan				
35035.SP.12	35035.SP.12	35035.SP.12	35035.SP.12	
Radsatz mit Zahnrad und Haftreifen				
35035.SP.13	35035.SP.13	35035.SP.13	35035.SP.13	
Radsatz mit Buchse und Feder				
35035.SP.14	35035.SP.14	35035.SP.14	35035.SP.14	
Radsatz mit Zahnrad				
35035.SP.15	35035.SP.15	35035.SP.15	35035.SP.15	
Dachstromabnehmer-Antrieb				

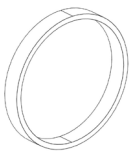
für Lokomotive BR 151 (ESU Art.-Nr. 31035, 31036, 31037, 31038)

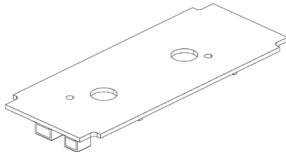
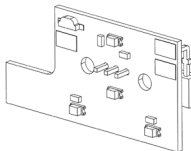
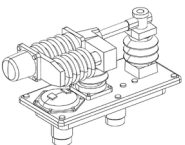
Artikel-Nr. Ersatzteile 151 070 DB (31035)	Artikel-Nr. Ersatzteile 151 088 DB (31036)	Artikel-Nr. Ersatzteile 151 087 DB (31037)	Artikel-Nr. Ersatzteile 162004 Hectorrail (31038)	
35035.SP.16	35035.SP.16	35035.SP.16	35035.SP.16	
Hauptplatine				
		35037.SP.19	35037.SP.19	
Dachstromabnehmer SBS 65 Einholm grau				
35030.SP.17	35030.SP.17	35030.SP.17	35030.SP.17	
Haftreifen (2 Stück)				
35035.SP.21	35035.SP.21	35035.SP.21	35035.SP.21	
Typhon				
35035.SP.23	35035.SP.23	35035.SP.23	35035.SP.23	
Leiterplatte Dachhaube				
35035.SP.24	35035.SP.24	35035.SP.24	35035.SP.24	
Leiterplatte Stirnbeleuchtung				
35035.SP.32	35036.SP.32	35037.SP.32	35038.SP.32	
Hauptschalter Dach				

für Lokomotive BR 151 (ESU Art.-Nr. 31035, 31036, 31037, 31038)

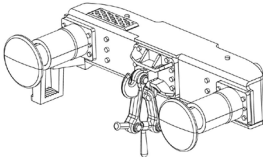
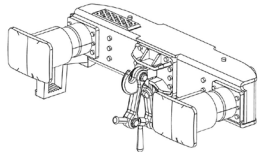
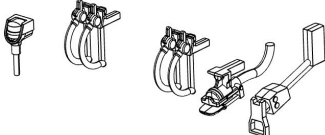
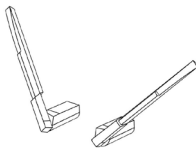
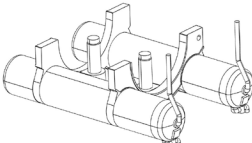
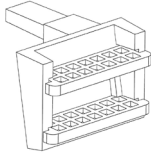
Artikel-Nr. Ersatzteile 151 070 DB (31035)	Artikel-Nr. Ersatzteile 151 088 DB (31036)	Artikel-Nr. Ersatzteile 151 087 DB (31037)	Artikel-Nr. Ersatzteile 162004 Hectorrail (31038)	
35035.SP.33	35035.SP.33			
Dachstromabnehmer DBS 54 Schere rot				
35035.SP.34	35036.SP.34			
Pufferträger mit Puffern rund				
		35037.SP.34	35037.SP.34	
Pufferträger mit Puffern eckig				
35035.SP.35	35035.SP.35	35035.SP.35	35035.SP.35	
Set Zurüstteile Front: Bremschläuche, E-Kupplung, Fernsteuerkabel				
35035.SP.36	35035.SP.36	35035.SP.36	35035.SP.36	
Scheibenwischer 2 Stück				
35035.SP.37	35036.SP.37	35035.SP.37	35035.SP.37	
Bauteile zwischen Drehgestellen				
35035.SP.39	35036.SP.39	35035.SP.39	35035.SP.39	
Set Trittstufen				

für Lokomotive BR 151 (ESU Art.-Nr. 31035, 31036, 31037, 31038)

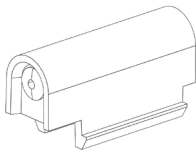
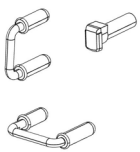
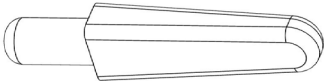
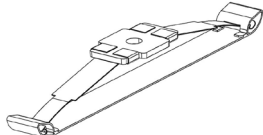
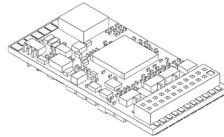
Artikel-Nr. Ersatzteile 151 070 DB (31035)	Artikel-Nr. Ersatzteile 151 088 DB (31036)	Artikel-Nr. Ersatzteile 151 087 DB (31037)	Artikel-Nr. Ersatzteile 162004 Hectorrail (31038)	
35035.SP.41	35035.SP.41	35037.SP.41	35037.SP.41	
Dach Abdeckung Stromabnehmerantrieb				
35035.SP.42	35036.SP.42	35037.SP.42	35038.SP.42	
Set Griffstangen und Steckdose Stirnseite				
35035.SP.43	35035.SP.43	35035.SP.43	35035.SP.43	
Antenne Schwert				
35080.SP.17	35080.SP.17	35080.SP.17	35080.SP.17	
Schleifer				
58419	58419	58419	58419	
Decoder				



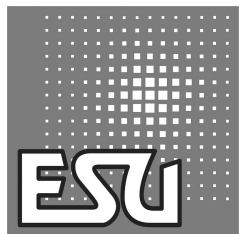

ESU P/N 04525-30195